

DRIVER

DR-DG-20-HO

22 Gbps High Output Voltage Driver

The DR-DG-20-HO is a driver module optimized for digital applications requiring an upper operation voltage. It exhibits 12.5 V_{pp} output voltage and 29 dB gain up to 23 GHz.

The DR-DG-20-HO module is especially useful for driving LiNbO₃ modulators with 22 Gbps DPSK and 2x20 Gbps (D)QPSK modulation formats. It is operated from a single power supply voltage for safety and ease of use and offers gain and cross-point control.

The DR-DG-20-HO comes with K type RF connectors (female in, male out) and with an optional heat-sink. It is a non-inverting and single ended amplifier.



Features

- High output voltage 12.5 V_{pp}
- High gain 29 dB
- Flat gain up to 20 GHz
- Single voltage power supply

Applications

- 22 Gbps DPSK
- 2x20 Gbps (D)QPSK
- Spectrum broadening

Options

- 13.5 V_{pp} output voltage
- Heat-sink
- Analog version

Related Equipments

- MXIQUER-LN-40, MX-LN-20 modulators
- MBC-DG Automatic Bias Controllers

Performance Highlights

Parameter	Min	Typ	Max	Unit
Cut-off frequencies	80 k	23 G	25 G	Hz
Output voltage	-	12.5	13.5	V _{pp}
Gain	-	29	-	dB
Saturated power	26	-	-	dBm
Added jitter	-	1.05	-	ps
Rise / Fall times	-	12 / 16	-	ps

Measurements for V_{bias} = 12 V, V_{amp} = 1.2 V, V_{xp} = 0.7 V, I_{bias} = 550 mA

20 Gbps Output Response

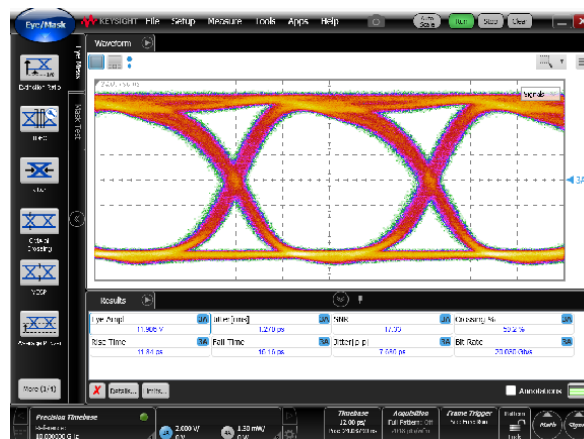

DR-DG-20-HO

22 Gbps High Output Voltage Driver

DC Electrical Characteristics

Parameter	Symbol	Min	Typ	Max	Unit
Supply voltage (fixed)	V_{bias}	-	12	13	V
Current consumption	I_{bias}	-	0.53	0.58	A
Gain control voltage	V_{amp}	0	1.5	2	V
Cross Point control voltage	V_{xp}	0	0.7	1	V

Electrical Characteristics

Parameter	Symbol	Condition	Min	Typ	Max	Unit
Lower frequency	$f_{3db'} \text{ lower}$	-3 dB point	-	-	80	kHz
Upper frequency	$f_{3db'} \text{ upper}$	-3 dB point	-	23	25	GHz
Gain	S_{21}	Small signal	-	29	-	dB
Gain ripple	-	$f < 17 \text{ GHz}$	-	± 1.5	-	dB
Input return loss	S_{11}	$50 \text{ kHz} < f < 18 \text{ GHz}$	-	-10	-	dB
Output return loss	S_{22}	$50 \text{ kHz} < f < 15 \text{ GHz}$	-	-10	-	dB
Saturated power	P_{sat}	$V_{in} = 0.65 V_{pp}$	26	-	-	dBm
Output voltage	V_{out}	$V_{in} = 0.65 V_{pp} @ 20 \text{ Gbps}$	-	12.5	$13.5 (V_{in} = 0.8 V_{pp}) V_{pp}$	V_{pp}
Rise / Fall time	t_r / t_f	20 % - 80 %	-	12 / 16	-	ps
Added Jitter	J_{RMS}	$J_{RMS} = \sqrt{J_{RMS-total}^2 - J_{RMS-source}^2}$	-	1.05	-	ps
Power dissipation	P	$V_{out} = 12.5 V_{pp}$	-	6.4	-	W

Conditions: $V_{in} = 0.65 V_{pp}$, $T_{amb} = 25 \text{ }^\circ\text{C}$, 50 W system

Absolute Maximum Ratings

Stresses in excess of the absolute maximum ratings can cause permanent damage to the device. These are absolute stress ratings only. Functional operation of the device is not implied at these or any other conditions in excess of those given in the operational sections of the data sheet. Exposure to absolute maximum ratings for extended periods can adversely affect device reliability.

Parameter	Symbol	Min	Max	Unit
RF input voltage	V_{in}	-	0.8	V_{pp}
Supply voltage	V_{bias}	-	13	V
DC current	I_{bias}	-	0.58	A
Gain control voltage	V_{amp}	0	2	V
Cross Point control voltage	V_{xp}	0	1	V
Power dissipation	P_{diss}	-	7.3	W
Operating temperature	T_{op}	0	40	$^\circ\text{C}$
Storage temperature	T_{st}	-20	+70	$^\circ\text{C}$

DR-DG-20-HO

S_{21} Parameter Curve

Conditions: $V_{bias} = 12\text{ V}$, $V_{amp} = 1.2\text{ V}$, $V_{xp} = 0.7\text{ V}$, $I_{bias} = 550\text{ mA}$

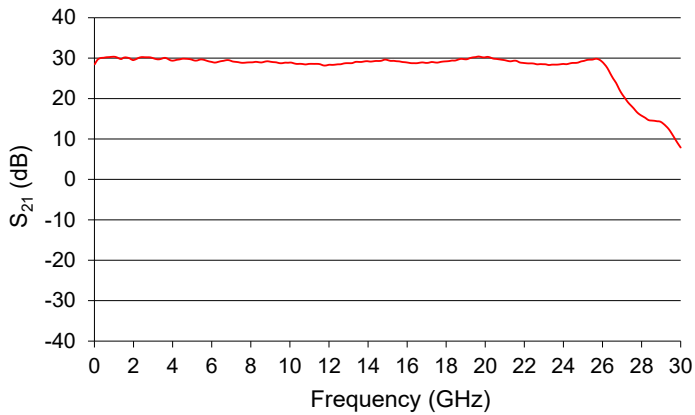

Group Delay Parameter Curve

Conditions: $V_{bias} = 12\text{ V}$, $V_{amp} = 1.2\text{ V}$, $V_{xp} = 0.7\text{ V}$, $I_{bias} = 550\text{ mA}$

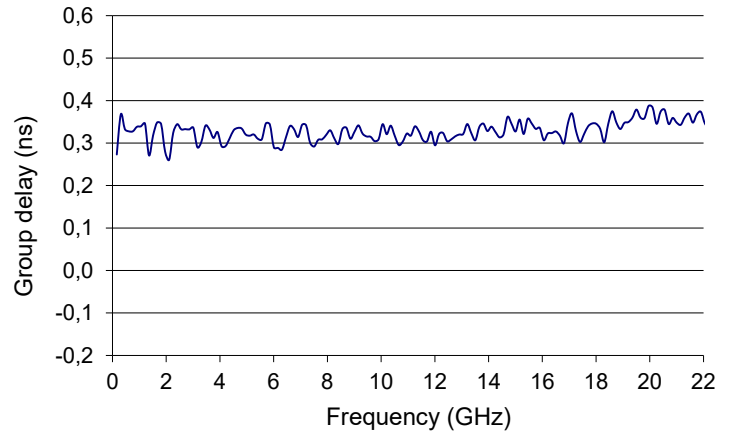

S_{22} Parameter Curve

Conditions: $V_{bias} = 12\text{ V}$, $V_{amp} = 1.2\text{ V}$, $V_{xp} = 0.7\text{ V}$, $I_{bias} = 550\text{ mA}$

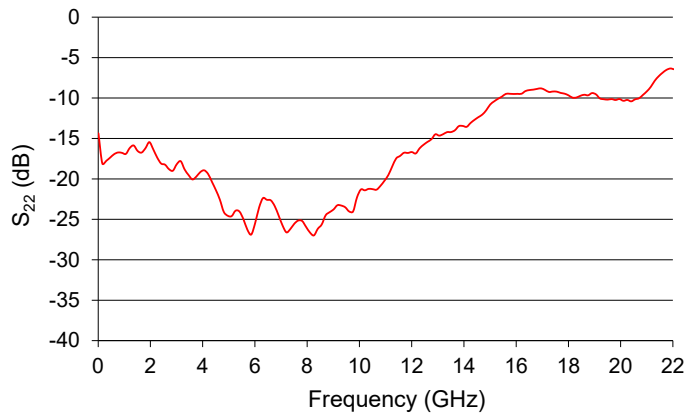

S_{11} Parameter Curve

Conditions: $V_{bias} = 12\text{ V}$, $V_{amp} = 1.2\text{ V}$, $V_{xp} = 0.7\text{ V}$, $I_{bias} = 550\text{ mA}$

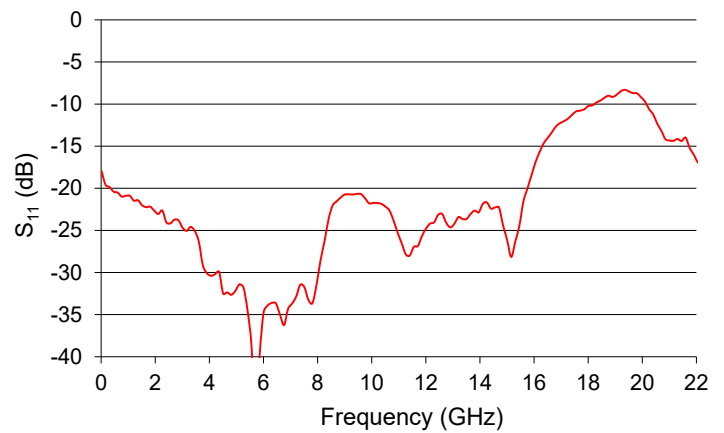

S_{12} Parameter Curve

Conditions: $V_{bias} = 12\text{ V}$, $V_{amp} = 1.2\text{ V}$, $V_{xp} = 0.7\text{ V}$, $I_{bias} = 550\text{ mA}$

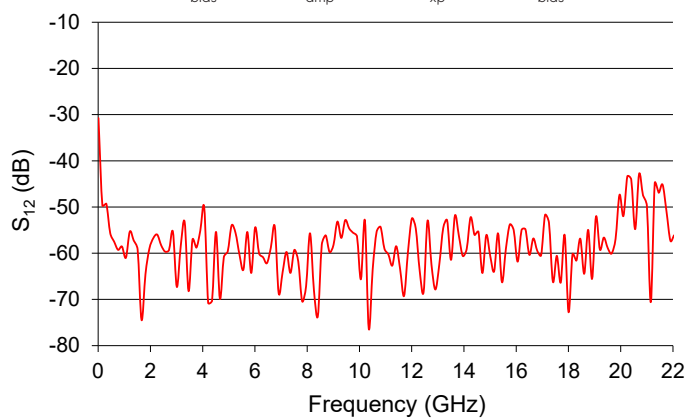

Noise Factor Curve

Conditions: $V_{bias} = 12\text{ V}$, $V_{amp} = 1.2\text{ V}$, $V_{xp} = 0.7\text{ V}$, $I_{bias} = 550\text{ mA}$

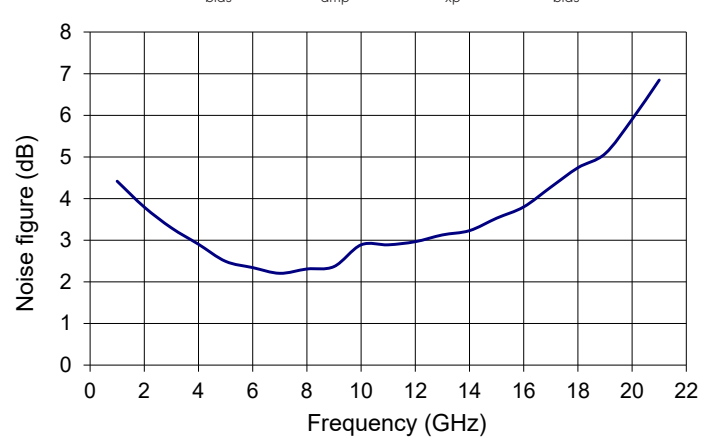

DR-DG-20-HO

Eye Diagrams

10 Gbps data rate

Conditions: Ratio 1/2, Pattern 2³¹-1

$$V_{\text{bias}} = 12 \text{ V}, V_{\text{amp}} = 1.4 \text{ V}, V_{\text{xp}} = 0.7 \text{ V}, I_{\text{bias}} = 501 \text{ mA}$$

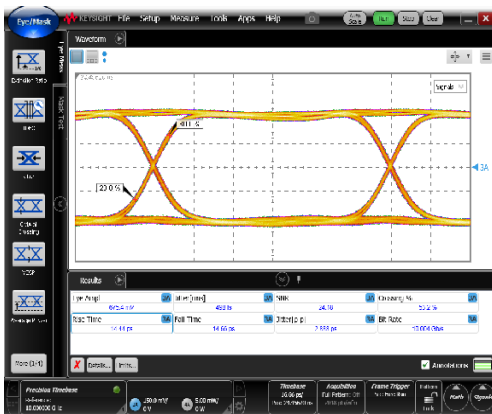

Input signal
Eye amplitude = 0.66 V_{pp}



Output response
Eye amplitude = 12.2 V_{pp}

20 Gbps data rate

Conditions: Ratio 1/2, Pattern 2³¹-1

$$V_{\text{bias}} = 12 \text{ V}, V_{\text{amp}} = 1.5 \text{ V}, V_{\text{xp}} = 0.8 \text{ V}, I_{\text{bias}} = 575 \text{ mA}$$

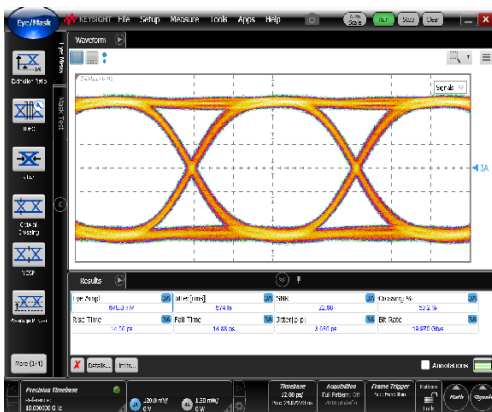

Input signal
Eye amplitude = 0.66 V_{pp}

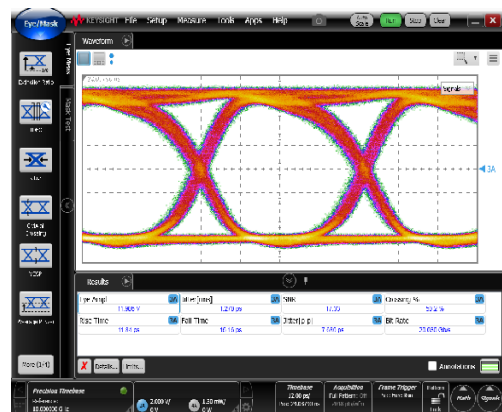

Output response
Eye amplitude = 11.9 V_{pp}

Electrical Schematic Diagram

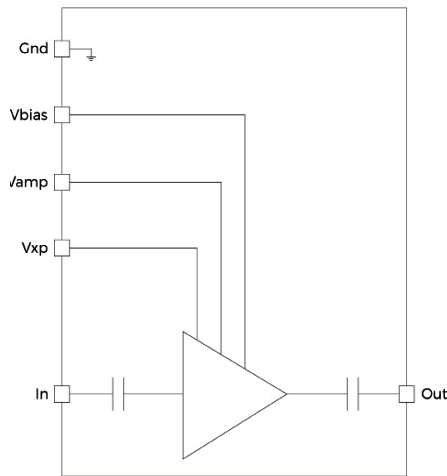

Mechanical Diagram and Pinout

All measurements in mm

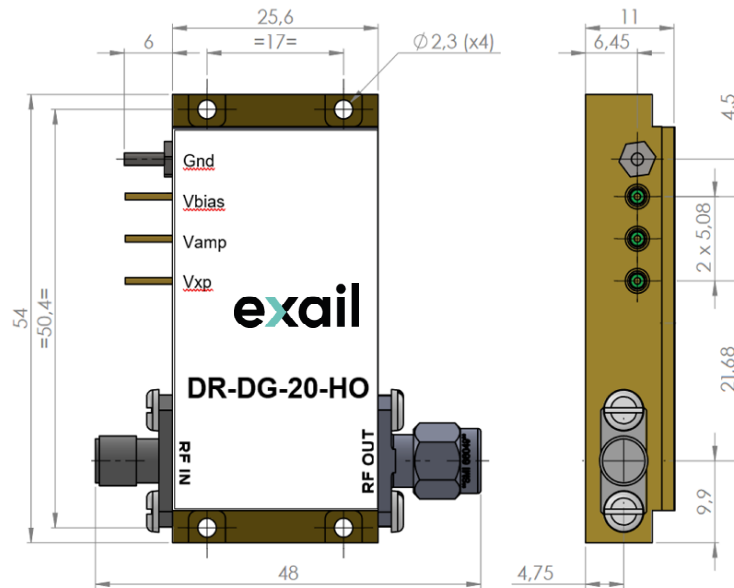

The heat-sinking of the module is necessary. It's user responsibility to use an adequate heat-sink. Refer to page 6 for Exail recommended heat-sink.

Port	Function	Unit
IN	RF In	Female K connector
OUT	RF Out	Male K connector
V_{bias}	Power supply voltage	Set a typical operating specification
V_{amp}	Output voltage amplitude adjustment	Adjust for gain control tuning
V_{amp}	Output voltage cross point adjustment	Adjust for cross point control tuning

DRIVER | DR-DG-20-HO | 6/6

Mechanical Diagram and Pinout with HS-HO1 Heat-sink

All measurements in mm

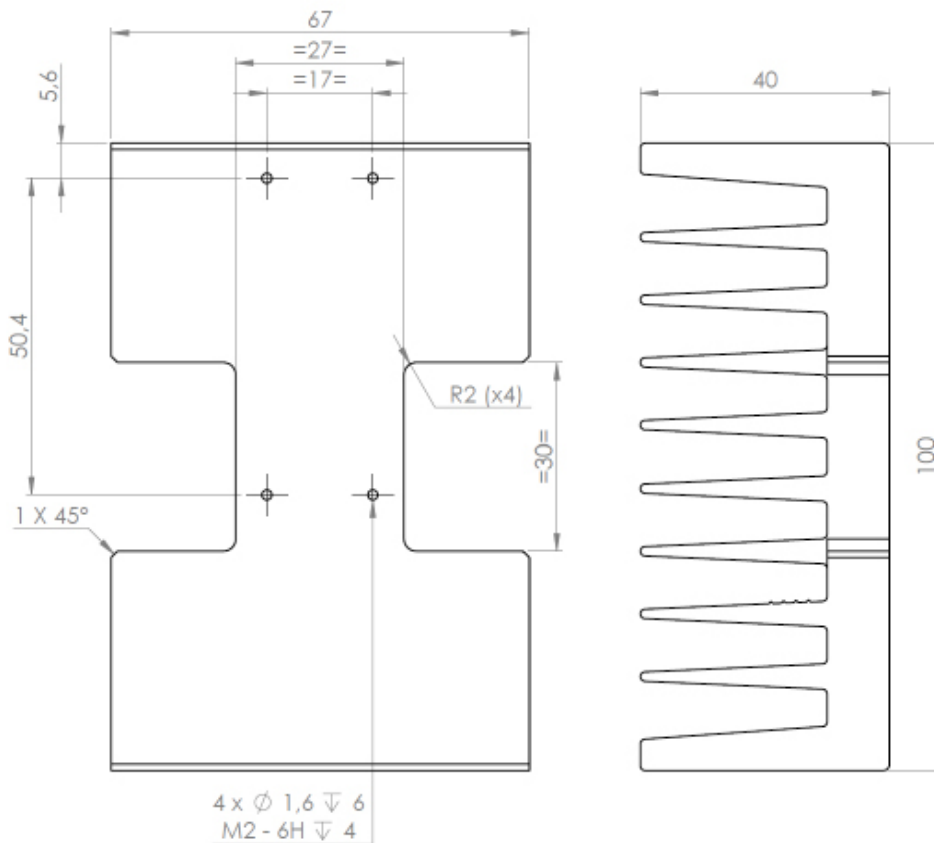
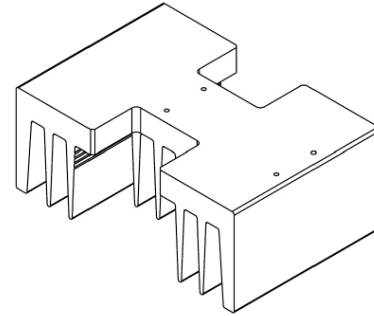

About us

Exail Photonics produces specialty optical fibers and Bragg gratings based fiber optics components and provides optical modulation solutions based on the company lithium niobate (LiNbO₃) modulators and RF electronic modules.

Exail Photonics serves a wide range of industries: sensing and instruments, defense, telecommunications, space and fiber lasers as well as research laboratories all over the world.

Exail reserves the right to change, at any time and without notice, the specifications, design, function or form of its products described herein. All statements, specification, technical information related to the products herein are given in good faith and based upon information believed to be reliable and accurate at the moment of printing. **However, Exail provides no warranty (whether express or implied or statutory) as to the description, sufficiency, accuracy or completeness, merchantability or fitness for a particular purpose of any information or specification detailed herein.** No liability is assumed for any inaccuracies and/or as a result of use of the products. The user must validate all parameters for each application before any use and he shall assume all risks and responsibilities in connection with the use of the products.